

Baseboard Registers & Grilles

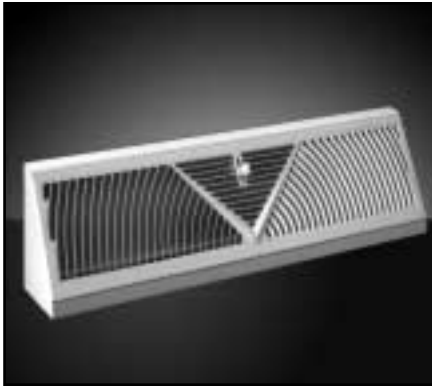

406 Baseboard Diffuser

- All-steel construction
- 406 blankets wall or window area
- Golden Sand or Bright White enamel finish

Catalog Number	Size	Free Area Sq. Inches	Overall Length	Height	Base Projection
406	15"	32	15	4-1/2	3
406	18"	38	18	4-1/2	2-13/16
407	18"	38	18	4-1/2	2-13/16

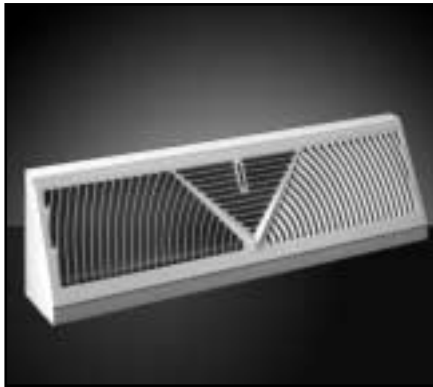
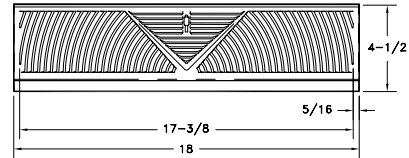

407 Matching Return Air Grille

- All-steel construction
- Complementary return air grille for Model 406 supply
- Golden Sand or Bright White enamel finish

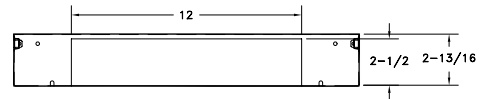

BOTTOM VIEW

406 18" Shown

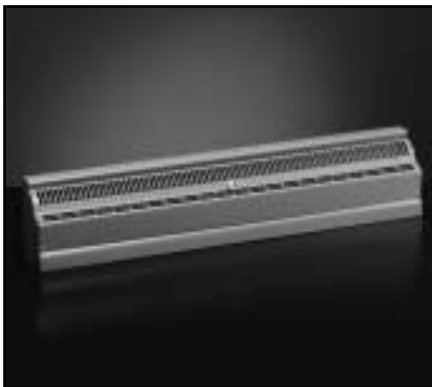

462 Baseboard Diffuser

- All-steel construction
- Two-foot length
- Airfoil valves reduce resistance
- Equal air distribution over the length of the diffuser
- Face can be easily removed
- Golden Sand or Bright White enamel finish

Catalog Number	Size	Free Area Sq. Inches	Overall Length	Height	Base Projection	Bottom Opening
462	2 ft.	27	24	4-1/2	2-23/32	2-5/16 x 16
472	2 ft.	42	24	4-1/2	2-23/32	2-5/16 x 16

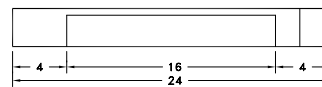

BOTTOM VIEW OF NO. 462

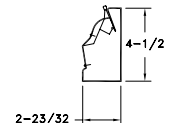

472 Matching Return Air Grille

- All-steel construction
- Two-foot length
- Complementary return air grille for Model 462 supply
- Golden Sand or Bright White enamel finish

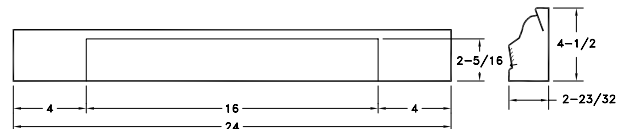

BOTTOM VIEW OF NO. 472

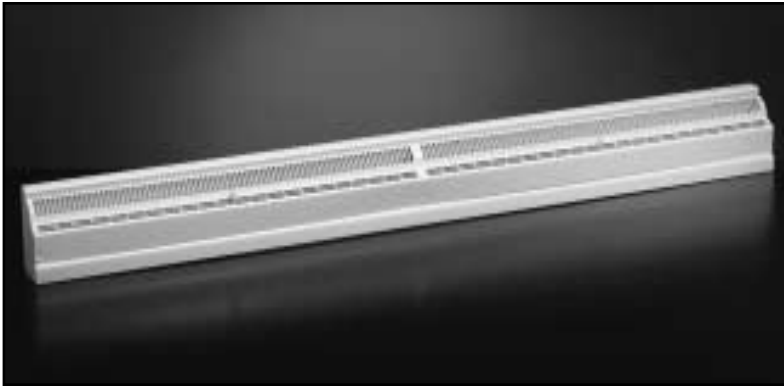

464 Baseboard Diffuser

- All-steel construction
- Four-foot length
- Airfoil valves reduce resistance
- Equal air distribution over the length of the diffuser
- Dual valves
- Face can be easily removed
- Golden Sand or Bright White enamel finish

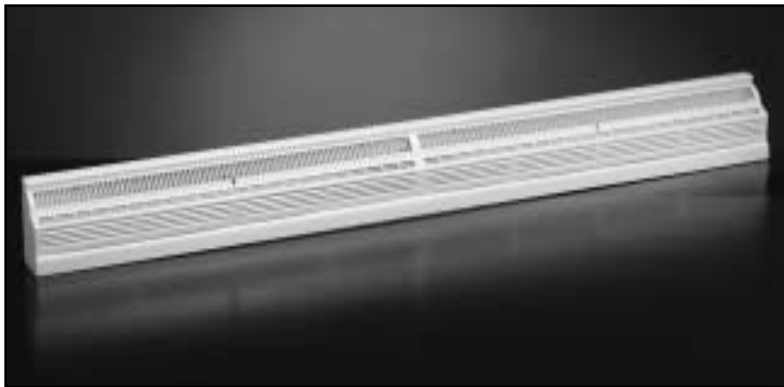

474 Matching Return Air Grille

- All-steel construction
- Four-foot length
- Complementary return air grille for Model 464 supply
- Golden Sand or Bright White enamel finish

Catalog Number	Size	Free Area Sq. Inches	Overall Length	Height	Base Projection	Bottom Opening
464	4 ft.	54	48	4-1/2	2-23/32	2-5/16 x 1/16
474	4 ft.	84	48	4-1/2	2-23/32	2-5/16 x 37-3/4

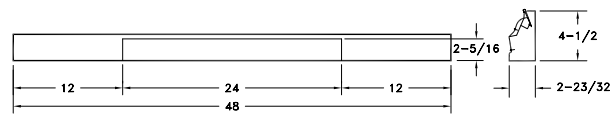

BOTTOM VIEW OF NO. 464

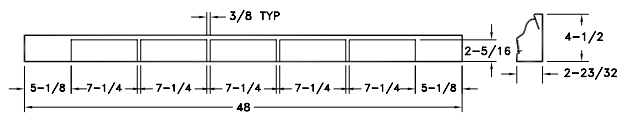

BOTTOM VIEW OF NO. 474



654 Baseboard Register with Damper

- One-piece steel construction
- 1/3" spaced fins set at 20 degrees
- 7/8" margin turnback
- Exceptional free area
- Positive volume-control damper
- Bright White enamel finish

654 Available Sizes (in.)			
HT	WIDTH		
		10	12
6	X	X	X

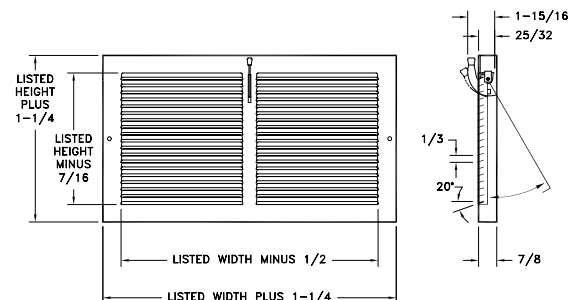

Baseboard Registers & Grilles



655 Baseboard Register with Damper

- All-steel construction
- 1/3" spaced fins set at 20 degrees
- Positive volume-control damper
- Bright White enamel finish

655 Available Sizes (in.)				
HT	WIDTH			
	6	8	10	12
	X	X	X	X

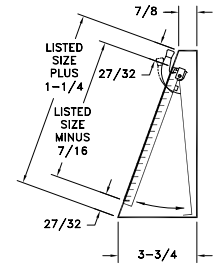
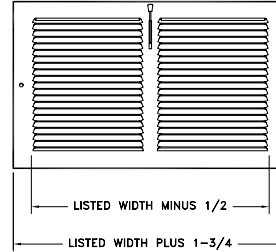

657 Baseboard Return Air Grille

- One-piece steel construction
- 1/3" spaced fins set at 20 degrees
- 7/8" margin turnback
- Exceptional free area
- Install with fins upward or downward for best duct concealment
- Complementary return air grille for Model 654 or 664 supply
- Golden Sand or Bright White enamel finish

657 Standard Sizes (in.)							
HT	WIDTH						
	4			X			
6	X	X	X	X	X	X	X
8	X	X	X	X	X	X	X
10			X		X	X	
12			X			X	X

Contact factory for sizes not listed

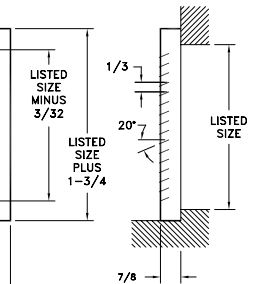
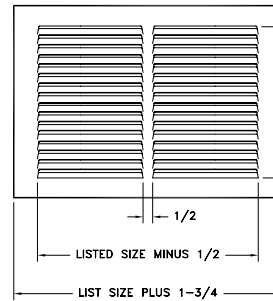

658 Baseboard Return Air Grille

- All-steel construction
- 1/3" spaced fins set at 20 degrees
- Complementary return air grille for Model 655 supply
- Bright White enamel finish

658 Available Sizes (in.)					
HT	WIDTH				
	6	10	12	14	24
8	X	X	X	X	X

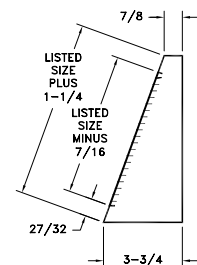
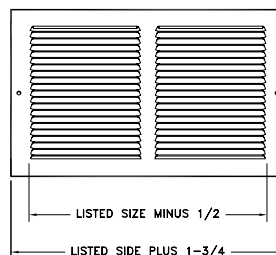



664 Baseboard Register

- All-steel construction
- 1/3" spaced fins set at 20 degrees
- 7/8" margin turnback
- 1-5/8" depth when fully opened
- Exceptional free area
- Ideal for shallow duct installations
- Multi-shutter valve
- Bright White enamel finish

664 Available Sizes (in.)				
HT	WIDTH			
	8	10	12	14
6	X	X	X	X
8			X	

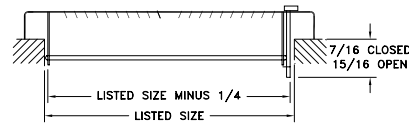
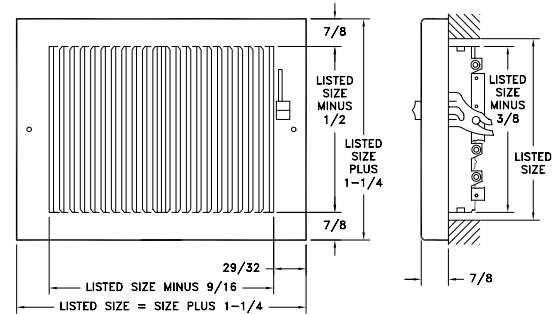

674 Return Air Grille

- One-piece steel construction
- 1/2" spaced fins set at 40 degrees
- 7/8" margin turnback
- Complementary return air grille for 1/2" spaced products
- Bright White enamel finish

674 Available Sizes (in.)			
HT	WIDTH		
	14	24	30
6	X	X	X
8	X	X	X

